

## **Mastery Professional Development** *Number, Addition and Subtraction*



### 1.28 Common structures and the part–part–whole relationship

Teacher guide | Year 5

#### **Teaching point 1:**

Mathematical relationships encountered at primary level are either additive or multiplicative; both of these can be observed within the structure of part–part–whole relationships.

#### **Teaching point 2:**

Problems in many different contexts can be solved by adding together the parts to find the whole. Different strategies can be used to calculate the whole, but the structure of the problem remains the same.

#### **Teaching point 3:**

If the value of the whole is known, along with the values of all but one of the parts, the value of the missing part can be calculated. Different strategies can be used to calculate the missing part, but the structure of the problem remains the same.

#### **Teaching point 4:**

Problems in many different contexts have the ‘missing-part’ structure.

## Overview of learning

In this segment children will:

- use concrete and pictorial representations to expose and compare multiplicative and additive structures
- build on prior learning on part–part–whole\* relationships to generalise about missing parts and wholes
- learn to identify and model the underlying mathematical structure present in a variety of contexts
- develop increased awareness of the commonality of additive mathematical structures (missing whole or missing part).

\*Note that, as we consider situations with various numbers of parts, we will often use the generalised term *part–part–whole* irrespective of the number of parts.

Children already have a lot of experience solving missing whole/sum and missing addend/part problems with two, three or more parts. For example, in the context of place value children have calculated a whole/sum, e.g.:

$$300 + 40 + 7 = \square$$

as well as a missing part, e.g.:

$$300 + \square + 7 = 347$$

This segment builds further on children’s understanding of parts and wholes. The aim is to deepen their understanding of different structures, enabling them to generalise, model and identify the structures that underpin a wide variety of problems.

In *Teaching point 1*, Cuisenaire® rods are used to represent part–part–whole structures, including examples with unequal parts (additive) or equal parts (which can be seen as either additive or multiplicative), and examples that are a mixture of the two (for example ‘*Stella has three packs of ten pencils and four more pencils*’). The use of Cuisenaire® rods allows children to develop a deep understanding of the structures without reference to specific numerical problems. Towards the end of *Teaching point 1*, children begin to sketch models as a link to using bar models. The rest of the segment (*Teaching points 2–4*) then provides a more detailed examination of additive part–part–whole relationships, using the bar model to reveal the commonality of structure in missing-whole problems (*Teaching point 2*) and missing-part problems (*Teaching points 3 and 4*), and to facilitate problem-solving in a variety of contexts.

Note that, as children progress through and beyond this segment, there is no need for teachers to rush to move children away from using the bar model. Once children’s understanding of part–part–whole structures deepens, they may be able to confidently solve problems without drawing a model. However, it is important to develop reflective mathematicians who are able to recognise when they are ‘stuck’, and who have sufficient confidence to draw models as needed to shed light on the structure of a problem. All children should experience (and be encouraged to enjoy!) this feeling of ‘stuckness’ and see the role that model drawing can sometimes play in moving them forwards from this position.

The inverse relationship between addition and subtraction plays an important role in this segment, so that children understand how and why we can rewrite missing-part/addend problems as subtraction problems (this is supported by the bar model). This allows calculation of missing parts using formal written subtraction methods, as well as mental methods (as appropriate). This segment also makes use of ‘mathematically incoherent situations’ in which the sum of the parts does not correspond to the

whole. As children explore the different ways to adapt such a situation in order to make it mathematically coherent, their understanding of the relationships in part–part–whole structures will deepen.

The national curriculum states that *'the programmes of study are, by necessity, organised into apparently distinct domains, but pupils should make rich connections across mathematical ideas to develop fluency, mathematical reasoning and competence in solving increasingly sophisticated problems.'* The aim of this segment is to draw attention to the fact that situations that occur in very different contexts can share the same underlying structure; the focus is on situations that share a common *structure* but different *contexts*, rather than a common *context* (such as many situations related to capacity) with different *structures*. For example, calculating the cost of two items and then working out change from £10 involves exactly the same part–part–part–whole structure as finding a missing angle in a triangle: in both cases, the whole ( $£10/180^\circ$ ) and two parts are known, and the third part needs to be calculated.

Throughout teaching, the focus should be kept on the *structures* rather than on the *solutions* to the problems, to ensure that children build firm foundations for future learning; children should not just be able to solve the problems within this segment but should develop a deep understanding that allows them to approach an unfamiliar problem. To help keep the focus on the structures, you should initially use problems with simple arithmetic; as children's recognition of structures improves, more challenging arithmetic can be included, along with discussion about useful and appropriate calculation strategies.



Once children can confidently model and solve additive problems involving *one* unknown (for example, *'80 children chose an orange, apple or banana for fruit break. 16 of the children chose oranges and 23 chose apples. How many chose bananas?'*), they will have solid grounding to move on to problems involving *two* unknowns (segment 1.31 *Problems with two unknowns*), where a relationship between the two unknowns is supplied (for example, *'80 children chose an orange, apple or banana for fruit break. 17 of the children chose oranges. Twice as many children chose apples as bananas. How many chose bananas?'*). Children will need to draw on the bar model extensively to solve such problems, and this segment builds strong foundations for that.

*An explanation of the structure of these materials, with guidance on how teachers can use them, is contained in this NCETM podcast: [www.ncetm.org.uk/primarympdpodcast](http://www.ncetm.org.uk/primarympdpodcast). The main message in the podcast is that the materials are principally for professional development purposes. They demonstrate how understanding of concepts can be built through small coherent steps and the application of mathematical representations. Unlike a textbook scheme they are not designed to be directly lifted and used as teaching materials. The materials can support teachers to develop their subject and pedagogical knowledge and so help to improve mathematics teaching in combination with other high-quality resources, such as textbooks.*

**Teaching point 1:**

Mathematical relationships encountered at primary level are either additive or multiplicative; both of these can be observed within the structure of part-part-whole relationships.

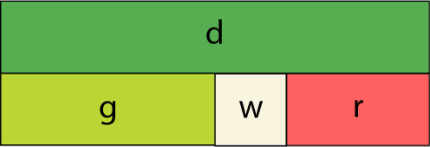
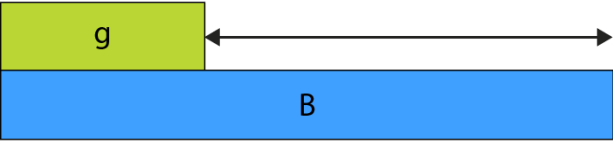
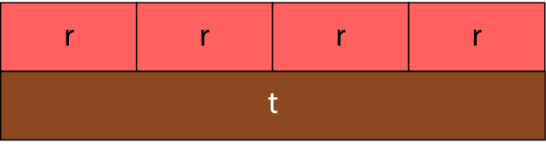
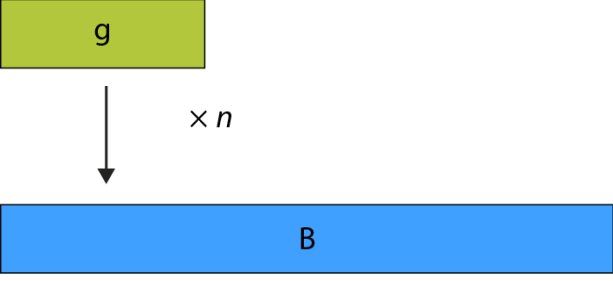
**Steps in learning**

	<b>Guidance</b>	<b>Representations</b>
<b>1:1</b>	<p>At primary school, children come across only two types of mathematical relationships: additive and multiplicative. Different examples are illustrated opposite with Cuisenaire® rods (see Appendix for an explanation of the colours and labelling of Cuisenaire® rods).</p> <p>A relationship is additive if the quantities are related through combining, partitioning or direct comparison, and involves the operation of addition or subtraction. A relationship is multiplicative if the quantities are related in a proportional sense and involves the operation of multiplication or division. Overlap between the two occurs within the context of repeated addition, which can be seen in both additive and multiplicative terms; this occurs within a part-part-whole structure where the parts are the same size and, in these instances, multiplication is often a more efficient strategy for calculation. The third example opposite can be seen as either <math>r+r+r+r</math> or <math>4 \times r</math>.</p> <p>This teaching point supports children in recognising additive and multiplicative relationships within a part-part-whole structure (1, 3 and 5 opposite) so that they can choose the most efficient calculation strategy when solving problems. The rest of the segment will then move forwards looking at commonality of additive structure within part-part-whole relationships and using this to solve problems.</p>	<p>Summary of relationships:</p> <ol style="list-style-type: none"> <li><b>Additive – combining or partitioning</b>   </li> <li><b>Additive – comparative</b>   </li> <li><b>Additive or multiplicative</b>   </li> <li><b>Multiplicative – scaling</b>   </li> <li><b>Additive and multiplicative combined</b>   </li> </ol>

This teaching point will use Cuisenaire® rods to model the mathematical relationships, progressing to sketched bar models. Note that there are a few things to be aware of when using Cuisenaire® rods:

- Use of the rods is dependent on colour recognition. Be aware of any children who may be colour-vision deficient and make adjustments accordingly (such as those made in the representations shown here). Take care not to inadvertently ascribe errors made by children to a lack of mathematical understanding in cases where they are actually due to colour-vision deficiency.
- Here we have supplemented the rods with symbols denoting the colour and use the standard rod names and symbols.
- Avoid describing (or encouraging children to see) the rods as having a specific number value; for example, instead of saying '*Two ones and a three is equivalent to a five*', ensure you say '*Two whites and a light green is equal to a yellow*' (or  $2w + g = y$  as in step 1:2).

If the children are not familiar with Cuisenaire® rods, give them some time to freely explore the rods. They will start to make observations and 'play around' with equivalence. As children start to make different structures, help them to describe the relationships in words, for example:

- '*I have found that red plus light green is equivalent to pink plus white.*'
- '*I can see that six yellows is equivalent to five dark greens.*'
- '*I have found three different pairs of rods that are equivalent to the dark green rod.*'

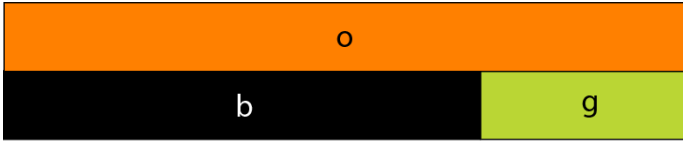
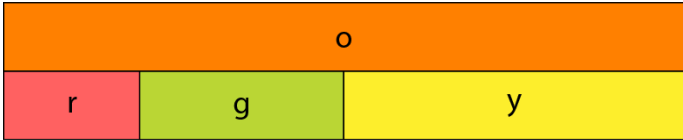
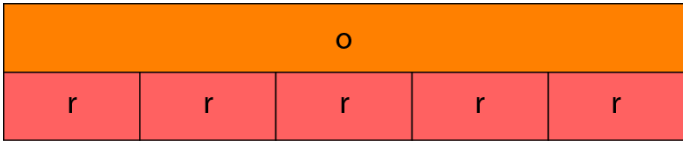
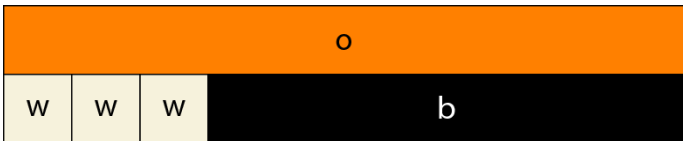
	Encourage children to express these observations to their partners.	
1:2	<p>After children have spent some time exploring freely, ask them to find rod combinations that are equivalent to the orange rod; specifically, ask one-by-one, for children to find combinations that satisfy the following conditions:</p> <ul style="list-style-type: none"> <li>• a pair of two <i>different</i> rods that together are equivalent to the orange rod</li> <li>• a group of three or more <i>different</i> rods that together are equivalent to the orange rod</li> <li>• a group of <i>identical</i> rods that together are equivalent to the orange rod</li> <li>• a group of identical rods and a group (could be a group of one) of different rods that all together are equivalent to the orange rod (i.e. a group where some are identical and some are different).</li> </ul> <p>For each combination of rods, describe the relationships in words (as in the step 1:1), but then also begin to write the expressions algebraically using the rod-colour symbols, as exemplified opposite. Note that the first example opposite exemplifies variation in position of the equals sign; whether you choose to have the equals sign at the start or the end of the equation, it is recommended that you keep the equations consistent <i>within</i> an activity to draw attention to what has changed in the structures.</p>	<p>Pair of two <i>different</i> rods (additive):</p>  <p><i>'Black plus light green is equal to orange.'</i>  <math>b + g = o</math></p> <p>or</p> <p><i>'Orange is equal to black plus light green.'</i>  <math>o = b + g</math></p> <p>Group of three <i>different</i> rods (additive):</p>  <p><i>'Red plus light green plus yellow is equal to orange.'</i>  <math>r + g + y = o</math></p> <p>Group of <i>identical</i> rods (multiplicative/repeated addition):</p>  <p><i>'Five red is equal to orange.'</i>  <math>5 \times r = o</math>      or      <math>r + r + r + r + r = o</math></p> <p>A group of <i>identical</i> rods and a <i>different</i> rod (additive and multiplicative):</p>  <p><i>'Three white plus one black is equal to orange.'</i>  <math>3 \times w + b = o</math>      or      <math>w + w + w + b = o</math></p>

**1:3**

Now show two different models with the rods (one additive and one multiplicative as shown opposite); ask children to make the models themselves and compare them:

- 'What's the same?'
  - In both models, the blue rod is the whole.
  - Both models have a light green part.
  - Both models have three parts.
- 'What's different?'
  - In model A, the three parts are different sizes; in model B, the three parts are the same size.
  - Model A contains a yellow rod and a white rod; model B doesn't contain either of these.

Support the children to be precise in the language they use.

Ask them to say whether they think each model has an additive structure, a multiplicative structure or either (as discussed earlier, examples such as model B can be seen as either multiplicative or additive). During the resulting discussion, you can encourage children to write equations to represent the relationships. Then show a few more pairs of models, asking them to state whether each is additive, multiplicative or either, explaining their reasoning each time.

Model A (additive):

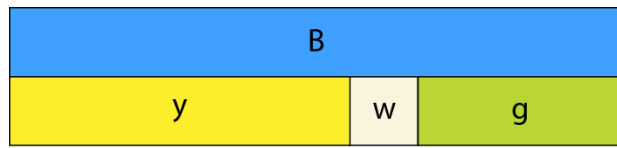

$$B = y + w + g$$

Model B (multiplicative/repeated addition):



$$B = g + g + g \quad \text{or} \quad B = 3 \times g$$

**1:4**

Now begin to link the models of part-part-whole structures to contextual problems. Throughout this and the next step, the focus should be on the *structures* rather than on *calculation*; children should not be finding the 'answers' (these will be included in the stories) but should instead be learning to interpret and model problems, identifying the underlying structures.

Additive:

'A bowl of fruit contains more apples than oranges, and more oranges than bananas.'

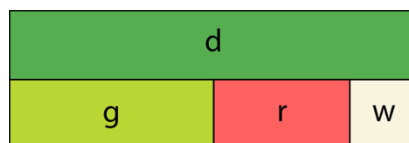



Prepare three different labelled models using Cuisenaire® rods, one for each of the following structures:

- additive
- multiplicative/repeated addition
- a combination of additive and multiplicative.

As discussed in the previous step, the first model opposite can be seen as either multiplicative or additive; the key is that the parts are the same size. Then tell a story corresponding to one of the models and ask children to identify and copy the model (building it using rods) that fits the story. Once the children have identified the correct model, ask them to sketch it. The resulting sketch model will essentially be a bar model without any numbers. Repeat with different stories, until all three models have been matched to a story and sketched. Example models and stories are shown opposite, already 'matched' for clarity.

Note that the stories shown opposite intentionally involve no numbers; this keeps the focus on structure and also ensures that children do not get distracted by trying to identify/draw a precise ratio for the 'parts'. Even when numbers are included in the contexts (step 1:5), it is important that children don't spend time trying to sketch 'accurate' models. Throughout this segment, children should be developing their ability to identify and model structures sufficiently to enable them to solve problems, so sketches and bar models need only have enough accuracy for it to be clear which parts are the same size and which are different.

Multiplicative/repeated addition:

*'A bowl of fruit contains equal quantities of apples, oranges and bananas.'*



Additive and multiplicative combined:

*'A bowl of fruit contains mostly apples, and equal numbers of oranges and bananas.'*



1:5

Now progress to telling a range of stories with part-part-whole structures (including numbers this time). For each, ask children to sketch a model to identify whether the structure is additive, multiplicative, either or both combined. The aim is to give children opportunities to generate and compare their own modelling and interpretation of the contexts. You can work towards use of the following generalised statements:

- **'A whole split into equal parts can be seen as both an additive and a multiplicative structure.'**
- **'A whole split into unequal parts can be seen as an additive structure.'**

The following are some example stories that you could use:

- *'A can of drink costs £1.50. I buy three cans of drink for £4.50.'*  
(multiplicative/repeated addition)
- *'I spend £30 buying a t-shirt, a DVD and a book.'*  
(could be any of the structures as we don't know how much each of the items costs)
- *'There are fifteen stickers on a sheet. Some are red, some are blue and some are green.'*  
(could be any of the structures as we don't know how many of each colour of sticker there are)
- *'Twenty children are having school dinners. Twelve of these are having pasta, two are having curry and the rest are having sandwiches.'*  
(additive)
- *'The three angles in an equilateral triangle add up to 180°.'*  
(multiplicative/repeated addition)
- *'The three angles in an isosceles triangle add up to 180°.'*  
(combined structure as two of the angles are the same)

Example story and sketch:

*'I have a four-metre length of wood. I cut it into three pieces of 2.2 m, 0.6 m and 1.2 m.'*

(additive)

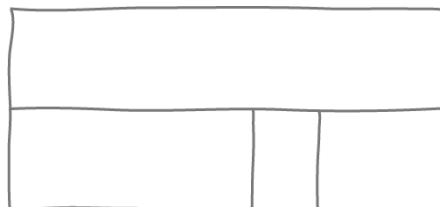

	<ul style="list-style-type: none"> <li>• <i>'I share some strawberries equally between three children.'</i> (multiplicative/repeated addition)</li> <li>• <i>'I give some strawberries to three children. Anya eats loads, Harvey eats some, but Rishi only gets one!'</i> (additive)</li> <li>• <i>'Pedro is allowed to watch half an hour of television after school. He watches three programmes.'</i> (could be any of the structures as we don't know how long each programme is)</li> </ul> <p>Note that in this step, children only <i>sketch</i> the models, rather than building them with Cuisenaire® rods; this avoids children focusing on trying to choose combinations of rods with precise ratios.</p>	
<p><b>1:6</b></p>	<p>Challenge the children to tell their own stories to go with the different structures.</p> <p>The stories may have all the parts (and the whole) quantified, for example:</p> <ul style="list-style-type: none"> <li>• <i>'I have eighteen toy cars. Two are blue, ten are black and six are red.'</i></li> </ul> <p>or they may have one or more parts (or the whole) unquantified, for example:</p> <ul style="list-style-type: none"> <li>• <i>'I have some toy cars. Two are blue, ten are black and six are red. How many toy cars do I have altogether?'</i></li> <li>• <i>'I have eighteen toy cars. Some are blue, some are black and some are red.'</i></li> </ul> <p>Encourage children to also include measures contexts such as money, time, distance, mass, and so on.</p>	

1:7

Now, in preparation for the next two teaching points, focus on cases where two or more of three parts are different (note that, in both cases, the structure can be seen as additive, the focus in this step will be on the idea that if we know two parts, there is only one possible value for the third part). Returning to the orange rod, challenge children to again find trios of rods that are equivalent to the orange.

Then create or describe some combinations and ask children to make them themselves. Initially, provide all three 'parts' (for example, white, red and black). Then progress to providing just two of the rods/parts (for example white and dark green), and challenge children to work out the missing rod/part. Through discussion, draw out that if we know the whole and two parts, there is only one possible value for the missing part.

Finally, move on to providing just one rod/part (for example 'one rod is yellow') and challenge children to identify the other two rods. Discuss how now, with two missing rods/parts, there is more than one possible solution.

All parts known/no missing parts:

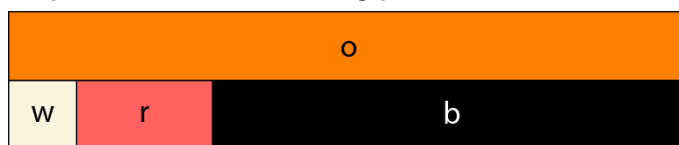

Two parts known/one missing part:



One part known/two missing parts:

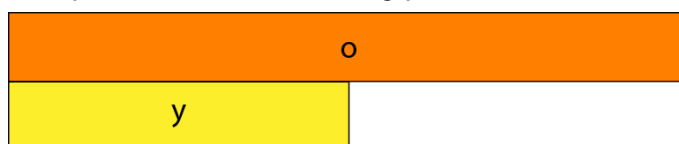

**Teaching point 2:**

Problems in many different contexts can be solved by adding together the parts to find the whole. Different strategies can be used to calculate the whole, but the structure of the problem remains the same.

**Steps in learning**

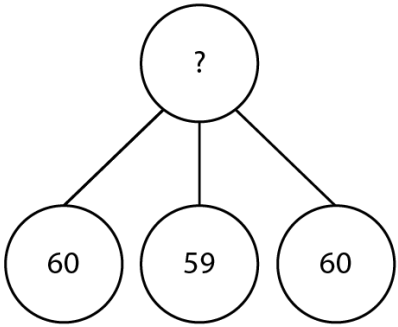
	<b>Guidance</b>	<b>Representations</b>														
<b>2:1</b>	<p>Throughout <i>Spine 1: Number, Addition and Subtraction</i>, children have come across many examples of adding together three or more parts/addends to find the whole/sum, including:</p> <ul style="list-style-type: none"> <li>• place value (e.g. <math>300 + 40 + 7 = 347</math>)</li> <li>• bridging ten (e.g. <math>8 + 5 = 8 + 2 + 3</math>)</li> <li>• contextual problems, for example totalling data sets in charts and tables.</li> </ul> <p>Children have also learnt that the addends can be added in any order (addition is associative).</p> <p>In the rest of this segment, we move forward with the additive structure explored in <i>Teaching point 1</i>, exploring the commonality of structure across a variety of contexts. In this teaching point, the focus is on combining the parts to make a whole, while the next teaching point explores problems with a missing part.</p> <p>Begin by presenting children with a three-addend context, such as the one opposite, and ask them to draw a diagram to represent the structure of the problem, now including the numbers. In the previous teaching point, children practised drawing 'preliminary' bar models (without numbers), but here they may also choose to draw the cherry model. Irrespective of the model they draw, ask children to describe what each part of their diagram represents (for example, 'The fifty-nine represents the number of children in Year 1.') Encourage</p>	<p>'Draw a diagram to represent the total number of children in Reception, Year 1 and Year 2.'</p> <table border="1"> <thead> <tr> <th>Year group</th> <th>Number of children</th> </tr> </thead> <tbody> <tr> <td>Reception</td> <td>60</td> </tr> <tr> <td>Year 1</td> <td>59</td> </tr> <tr> <td>Year 2</td> <td>60</td> </tr> </tbody> </table>  <table border="1"> <tbody> <tr> <td colspan="3" style="text-align: center;">?</td> </tr> <tr> <td style="text-align: center;">60</td> <td style="text-align: center;">59</td> <td style="text-align: center;">60</td> </tr> </tbody> </table>	Year group	Number of children	Reception	60	Year 1	59	Year 2	60	?			60	59	60
Year group	Number of children															
Reception	60															
Year 1	59															
Year 2	60															
?																
60	59	60														

children to move towards use of the bar model (in preference to the cherry model) so that they are very confident with it by the time they get to segment 1.31 *Problems with two unknowns*.

You can remind children of the following form of stem sentence with which they should be familiar from earlier work on the part-part-whole (two parts) model: '**\_\_\_ is the whole; \_\_\_ is a part, \_\_\_ is a part and \_\_\_ is a part.**'

Note the following important points:

- The main reason for encouraging children to draw models is to provide insight into the structure of a problem to help them to solve it. In this case, many children will be able to see how to solve the calculation without the need for a bar model and they may question why you are asking them to draw it. Explain that we are practising drawing models with familiar structures and contexts so that they will be able to confidently draw models to identify structures in unfamiliar contexts.
- The focus at this stage is not on solving the relatively simple calculation but instead on exploring structure and building firm foundations for future learning. As you progress through the rest of the segment, encourage the use of efficient calculation strategies (for example, here the calculation is probably most-easily performed as  $3 \times 60 - 1$ ), but keep the main focus on the structure.

Discuss when it is appropriate, or not, to draw the bars such that they are proportional to the size of the numbers being represented:

- In some cases, making the bars roughly proportional will help

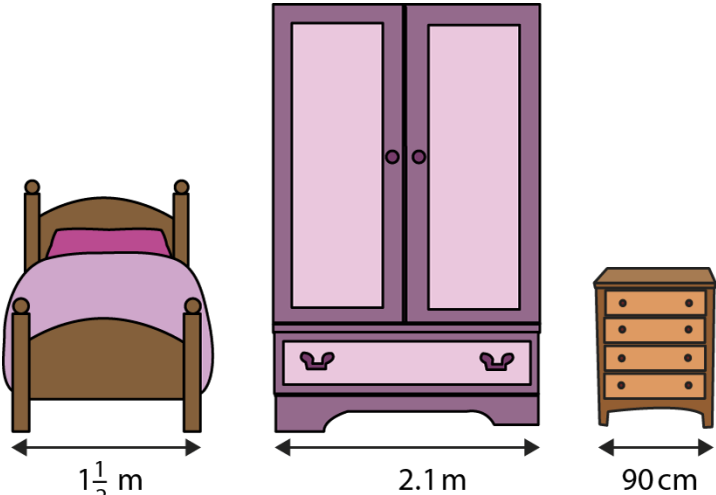
	<p>children to solve the problem more effectively.</p> <ul style="list-style-type: none"> <li>• In other cases, a rough sketch, with little attention given to proportion, may be sufficient to reveal the structure.</li> </ul> <p>There are no hard-and-fast rules. Keep in mind that the main purpose of drawing a model is to help 'unpick' the <i>structure</i> of the problem, which is independent of the specific numbers involved.</p>	
2:2	<p>Examine the bar model from step 2:1 and consider whether a different story could be told corresponding to the model. Generate some possibilities as a group. Initial suggestions from children may be very similar to the example already discussed (i.e. involving children and different year-groups); prompt children to then broaden to different contexts, for example:</p> <ul style="list-style-type: none"> <li>• 'Can you tell a story about animals?'</li> <li>• 'Can you tell a story about money?'</li> <li>• 'Can you tell a story about swimming?'</li> <li>• 'Can you tell a story about distances?'</li> </ul>	
2:3	<p>Now present children with a different context. Here you could use numbers with mixed units, such as the example shown opposite, to give children some experience of working with problems presented in this way. Ask children to represent the problem using a bar model (some may represent the example opposite using the mixed units in the question, while others may convert to a common unit).</p> <p>Show the resulting problem and bar model alongside those used in step 2:1, and ask children to compare the situations:</p> <ul style="list-style-type: none"> <li>• 'What's the same?'</li> <li>• Both problems have an additive structure.</li> </ul>	<p><i>'If I line the three pieces of furniture up along a wall, side-by-side, what length of the wall do they take up in total?'</i></p> 

	<ul style="list-style-type: none"> <li>Both structures consist of three parts that make up a whole.</li> <li><i>'What's different?'</i></li> <li>One problem is about children and one is about furniture.</li> <li>One problem involves measures and the other doesn't.</li> <li>One problem contains mixed units.</li> <li>One set of numbers may be easier to add together than the other set.</li> </ul> <p>Discuss any similarities and differences that children suggest and then draw attention to the structural similarities.</p> <p>This second example not only offers a different context, but also provides an opportunity to discuss conversion of units and addition strategies; adding together 2.1 m and 0.9 m first is probably the simplest approach. Continue to encourage children to recognise such efficiencies.</p>	<table border="1" style="margin-bottom: 20px;"> <tr><td colspan="3" style="text-align: center;">?</td></tr> <tr><td style="text-align: center;"><math>1\frac{1}{2}</math> m</td><td style="text-align: center;">2.1 m</td><td style="text-align: center;">90 cm</td></tr> </table> <table border="1"> <tr><td colspan="3" style="text-align: center;">? m</td></tr> <tr><td style="text-align: center;">1.5 m</td><td style="text-align: center;">2.1 m</td><td style="text-align: center;">0.9 m</td></tr> </table>	?			$1\frac{1}{2}$ m	2.1 m	90 cm	? m			1.5 m	2.1 m	0.9 m
?														
$1\frac{1}{2}$ m	2.1 m	90 cm												
? m														
1.5 m	2.1 m	0.9 m												
2:4	<p>As before, ask children to tell other stories to go with the same bar model. Again, children may initially suggest other contexts with lengths, such as:</p> <ul style="list-style-type: none"> <li><i>'I have 1.5 m of red ribbon, 2.1 m of blue ribbon and 0.9 m of yellow ribbon. How much ribbon do I have altogether?'</i></li> </ul> <p>Encouraging children to change the unit of measure will allow for different contexts, for example:</p> <ul style="list-style-type: none"> <li><i>'I am making a cake. I use 2.1 kg of flour, 1.5 kg of butter and 0.9 kg of sugar. How much do these ingredients weigh altogether?'</i></li> <li><i>'I spend £2.10 on a sandwich, £1.50 on a drink and 90p on some crisps. How much do I spend altogether?'</i></li> </ul>	<p><i>'Tell a story to go with this representation.'</i></p> <table border="1" style="margin-left: auto; margin-right: auto;"> <tr><td colspan="3" style="text-align: center;">?</td></tr> <tr><td style="text-align: center;">1.5</td><td style="text-align: center;">2.1</td><td style="text-align: center;">0.9</td></tr> </table>	?			1.5	2.1	0.9						
?														
1.5	2.1	0.9												



2:5

In order to secure the concept of several parts making a whole and how contextual word problems can be modelled, present children with a part-part-whole representation and ask them to tell a story to match the structure. Here children must interpret the representation without first seeing an example (in contrast to steps 2:2 and 2:4).

You can then ask children to calculate the sum of the parts, discussing appropriate strategies. For example, you could compare the two worked examples opposite, asking:

- 'Which strategy do you prefer?'
- 'Are there any other strategies you could use?'

*'Tell a story to go with this representation.'*

?		
30 minutes	20 minutes	55 minutes

Possible calculation strategies:

- Method A

$$\begin{aligned}
 30 + 20 + 55 &= 50 + 55 \\
 &= 105 \\
 &\quad \swarrow \quad \searrow \\
 &60 \quad 45 \\
 &= 1 \text{ hr } 45 \text{ mins}
 \end{aligned}$$

- Method B

$$\begin{array}{l}
 55 + 5 = 60 \\
 30 + 15 = 45
 \end{array}
 \left. \vphantom{\begin{array}{l} 55 + 5 = 60 \\ 30 + 15 = 45 \end{array}} \right\} 1 \text{ hr } 45 \text{ mins}$$

2:6

Now, to deepen children's understanding of the various relationships between the parts and the whole, present a mathematically incoherent story and model to the class, such as the example opposite.

Ask children how the model could be adjusted to make it mathematically coherent. For the example opposite, options include:

- increasing the whole/sum by ten, i.e. '**110** children choose a sport at an activity afternoon...'
- decreasing one part/addend by ten, for example, '**100** children choose a sport at an activity afternoon. **22** choose football, **40** choose basketball and **38** choose rounders.'
- decreasing several parts, by a total of ten, for example, '**100** children choose a sport at an activity afternoon. **30** choose football, **40** choose basketball and **30** choose rounders.'

*'100 children choose a sport at an activity afternoon. 32 choose football, 40 choose basketball and 38 choose rounders.'*

100		
32	40	38

*'How could you change the bar model to make it correct?'*

2:7

Provide children with contextual practice combining three (or more) parts to make a whole, including measures contexts with mixed units, such as those shown opposite and below:

- 'Anya eats 19 strawberries, Harvey eats 7 strawberries, and Rishi eats only one. How many strawberries do they eat altogether?'
- 'Jenny runs for 2 km, then walks for 350 m, and then runs for another 1.65 km. How far does she go?'
- 'Jacob spends 39 p on an apple, £1.25 on a sandwich and 50 p on a chocolate bar. How much does he spend?'
- 'Ellie needs to share one litre of juice between three bottles. She says she can split the juice into 250 ml, 300 ml and 350 ml. Is she correct? How could she share the juice between the three bottles?'

- 'Noah draws this diagram.'

8.5		
4.25	1.75	2.75

- 'Is it correct?'
  - 'How could you change it to make it correct?'
  - 'Can you think of another way?'
  - 'And another?'
- 'The graph shows the approximate number of tickets sold for three different events at the 2012 London Olympics. Each value is rounded to the nearest 50,000.'

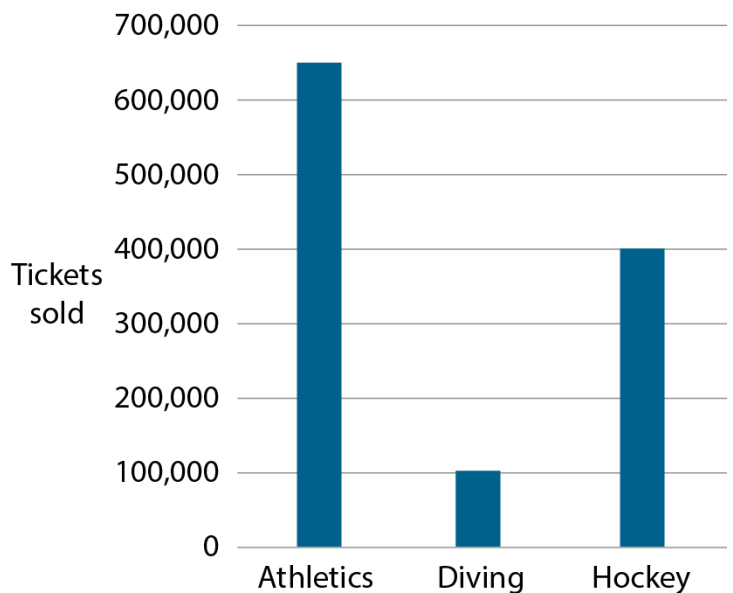

Source: London Datastore  
Public sector information licensed under the [Open Government Licence v2.0](#)

'Felicity says that about 1,100,000 tickets were sold in total for these three events. Is she correct?'

- *'The table shows the population of four islands. What is the total population of all four islands?'*

<b>Island</b>	<b>Approximate population in 2016 (thousands)</b>
Isle of Wight	140
Isle of Man	83
Guernsey	62
Jersey	104

**Teaching point 3:**

If the value of the whole is known, along with the values of all but one of the parts, the value of the missing part can be calculated. Different strategies can be used to calculate the missing part, but the structure of the problem remains the same.

**Steps in learning**

	<b>Guidance</b>	<b>Representations</b>						
<b>3:1</b>	<p>Throughout <i>Spine 1: Number, Addition and Subtraction</i>, children have solved missing-part problems (for both two- and three-part structures), including:</p> <ul style="list-style-type: none"> <li>• place value (e.g. <math>347 = 300 + ? + 7</math>)</li> <li>• finding change/calculating money left, for example, 'Joe gets £10 for his birthday. He spends £4.99 on a book and £3.50 on an ice-cream sundae. How much does he have left?'</li> </ul> <p>Children have also learnt that they can either subtract the parts/subtrahends one after the other or first add the parts/subtrahends and then subtract that total from the minuend (see segment 1.25 <i>Addition and subtraction: money, Teaching point 5: 'repeated subtract' vs 'adding first'</i>).</p> <p>In this teaching point, we continue with the additive structure, now exploring missing-part problems and the commonality of <i>this</i> structure across a variety of contexts. Begin by referring back to step 1:7, reminding children that if we know the whole and two of the three parts, there is only one possible value for the missing part.</p> <p>Then present children with a missing-part context, such as the one opposite, and ask children to draw a diagram to represent the structure of the problem, now including the numbers. Encourage children to use a question mark to represent the unknown, ensuring they understand what part of the context it represents. At this stage, don't ask children to calculate the missing part;</p>	<p>'80 children chose an orange, apple or banana for fruit break. 16 children chose oranges and 23 chose apples. How many chose bananas?'</p> <table border="1" style="margin-left: auto; margin-right: auto;"> <tr> <td colspan="3" style="text-align: center;">80</td> </tr> <tr> <td style="text-align: center;">16</td> <td style="text-align: center;">23</td> <td style="text-align: center;">?</td> </tr> </table>	80			16	23	?
80								
16	23	?						

	<p>instead, ask them to identify what calculation needs to be performed. They may write a missing-addend equation:</p> $16 + 23 + ? = 80$ <p>or they may directly write down a subtraction equation:</p> $80 - 16 - 23 = ?$ <p>In either case, prompt children (if necessary) to reframe the problem as the subtraction of two parts from the whole. The key here is for children to realise that the calculation can be written as either a missing addend equation or, crucially, as a subtraction calculation; some children may not initially see the possibility of reframing as a subtraction calculation, but by doing so they can then more easily see that they can apply any of their subtraction strategies. When actually calculating the answer, there are two main approaches for solving the problem, irrespective of how children have framed the problem (missing addend vs subtraction equation): they can either add the parts and subtract that sum from the whole (using known subtraction strategies, including working forwards from the sum of the parts, column methods, etc.) or subtract the parts one after another (again using appropriate strategies). These are discussed in more detail in the next step.</p>	
<p><b>3:2</b></p>	<p>After focusing on the structure of the missing-part problem in step 3:1, you can ask children how they might calculate the answer. They may suggest both the 'repeated subtraction' (i.e. 'subtract twice') and 'adding first' strategies (segment 1.25 <i>Addition and subtraction: money</i>). Ask children which strategy they prefer and why. (Note the particular strategies chosen to carry out</p>	<p>'Repeated subtraction' strategy:</p> $80 - 16 = 64$ $64 - 23 = 41$ <p>'Adding first' strategy:</p> $16 + 23 = 39$ $80 - 39 = 41$

	<p>the constituent addition/subtraction calculations will depend on the numbers involved, but efficient choices should be encouraged).</p> <p>Note that the 'adding first' strategy becomes more efficient when there are several parts, for example: <i>'Jess spent all £10 of her pocket money. She bought a DVD for £4, a notebook for £2.25, a pencil case for £1.20, a pen for 45 p and spent the rest on sweets. How much did Jess spend on sweets?'</i> This is especially true when column addition is required, because all parts can be added together in one step and then subtracted from the whole.</p> <p>It is important to have this discussion about choice of strategy, as it will be relevant to all of the missing-part problems. However, in the next step, the focus should then return to identifying the structure of problems.</p>	
3:3	<p>Present several more missing-part problems, asking children to draw a bar model and identify the required calculation in each case. Do not continue to actually carry out those calculations. Instead, focus on the structures, working towards the following generalised statement:</p> <ul style="list-style-type: none"> <li>• <b><i>'If a known whole is split into three parts and we know the value of two of them, we can find the missing part:</i></b> <ul style="list-style-type: none"> <li>• <b><i>'the whole minus the two known parts is equal to the missing part</i></b></li> <li>• <b><i>'the sum of the two parts plus the missing part is equal to the whole.'</i></b></li> </ul> </li> </ul> <p>You can extend to problems with more than three parts, generalising further:</p> <ul style="list-style-type: none"> <li>• <b><i>'If we know the value of the whole, and all but one of the parts, we can find the missing part:</i></b></li> </ul>	

	<ul style="list-style-type: none"> <li>• <b><i>'the whole minus the known parts is equal to the missing part</i></b></li> <li>• <b><i>'the sum of the known parts plus the missing part is equal to the whole.'</i></b></li> </ul>																									
<p><b>3:4</b></p>	<p>Once you have made the generalisation, continue to work through some more examples as a class, now calculating the answers, including:</p> <ul style="list-style-type: none"> <li>• varying the position of the missing part (in both the story and the model)</li> <li>• measures contexts (same unit and mixed units).</li> </ul> <p>Throughout, refer to the generalisations from step 3:3 and highlight the common structure.</p>	<p>Measures and varying the position of the missing part:</p> <p><i>'Jack mixes together some flour, 125 g butter and 55 g sugar. All the ingredients together weigh 360 g. How much flour does Jack use?'</i></p> <table border="1" data-bbox="778 622 1465 775"> <tr> <td colspan="3" style="text-align: center;">360 g</td> </tr> <tr> <td style="text-align: center;">?</td> <td style="text-align: center;">125 g</td> <td style="text-align: center;">55 g</td> </tr> </table> <p>Mixed units:</p> <p><i>'I have 1 m of ribbon. I cut off 0.5 m to use for a hair tie and another 15 cm to use for a bracelet. How much do I have left?'</i></p> <table border="1" data-bbox="778 1021 1465 1173"> <tr> <td colspan="3" style="text-align: center;">1 m</td> </tr> <tr> <td style="text-align: center;">0.5 m</td> <td style="text-align: center;">15 cm</td> <td style="text-align: center;">?</td> </tr> </table> <table border="1" data-bbox="778 1196 1465 1348"> <tr> <td colspan="3" style="text-align: center;">1 m</td> </tr> <tr> <td style="text-align: center;">0.5 m</td> <td style="text-align: center;">0.15 m</td> <td style="text-align: center;">?</td> </tr> </table> <table border="1" data-bbox="778 1370 1465 1523"> <tr> <td colspan="3" style="text-align: center;">100 cm</td> </tr> <tr> <td style="text-align: center;">50 cm</td> <td style="text-align: center;">15 cm</td> <td style="text-align: center;">?</td> </tr> </table>	360 g			?	125 g	55 g	1 m			0.5 m	15 cm	?	1 m			0.5 m	0.15 m	?	100 cm			50 cm	15 cm	?
360 g																										
?	125 g	55 g																								
1 m																										
0.5 m	15 cm	?																								
1 m																										
0.5 m	0.15 m	?																								
100 cm																										
50 cm	15 cm	?																								

3:5

You can deepen children's understanding by offering them opportunities to reason around part-part-whole structures, as in the example opposite.

'Rahul is solving a word problem involving favourite drinks. He draws this representation.'

drinks		
lemonade	milk	juice

'Use Rahul's model to decide whether the following equations are true or false.'

	True (✓) or false (✗)?
lemonade + milk + juice = drinks	
drinks – lemonade = milk + juice	
milk = drinks – juice	

'Rahul writes the following, correct equation.'

$$\text{juice} = \text{drinks} - \text{lemonade} - \text{milk}$$

'Complete these similar equations.'

$$\underline{\hspace{2cm}} = \text{drinks} - \text{lemonade} - \text{juice}$$

$$\text{lemonade} = \underline{\hspace{2cm}} - \text{milk} - \underline{\hspace{2cm}}$$

'Use the equations to complete this table of data about different year-groups' favourite drinks.'

	Year 1	Year 2	Year 3
number of children asked about their favourite <b>drink</b>	62	58	59
number who like <b>milk</b> best		13	21
number who like <b>lemonade</b> best	20		18
number who like <b>juice</b> best	12	35	



3:6

To complete this teaching point, present an identical structure but not set in context, e.g.:

$$999 = 345 + \square + 198$$

Children will have solved such problems many times, but again, the focus is on the structure.

Initially look at just the equation. Ask children:

- *'How is this similar to the other problems we have been solving?'*  
Here we still have a missing part. We still know the value of the whole and of two of the parts. The relationships between the parts and whole is still the same.
- *'How is it different?'*  
Now we don't have a 'story'; the problem is 'abstract' since we are just working with, for example, just 345, rather than 345 of something.

Ask children to represent the problem with a bar model to highlight the similarities, and to describe the link between the bar model and the missing-addend equation. In time, we want the equation itself to 'provoke' a structure in children's minds; practising explicitly linking the equation to the representation will help to secure this. Again, remind children of the generalisations already used in this teaching point.

Once you have fully explored the structure, you can move on and actually calculate the value of the missing part, discussing appropriate strategies. Sometimes children will solve missing-part/addend calculations like this by using a 'working forwards' strategy (i.e. working forwards from the sum of the known parts to the whole), for example:

Missing-addend problem – example 1:

$$999 = 345 + \square + 198$$

- Bar model

999		
345	?	198

- Using part-whole language to link the equation to the model

$$\begin{array}{c} 999 \\ \hline \downarrow \\ \text{whole} \end{array} = \begin{array}{c} 345 + \square + 198 \\ \hline \downarrow \\ \text{three parts} \end{array} \quad 5.73$$

Missing-addend problem – example 2:

$$15.1 = \square + 2.55 + 5.73$$

- Bar model

15.1		
?	2.55	5.73

- Using part-whole language to link the equation to the model

$$\begin{array}{c} 15.1 \\ \hline \downarrow \\ \text{whole} \end{array} = \begin{array}{c} \square + 2.55 + 5.73 \\ \hline \downarrow \\ \text{three parts} \end{array}$$

<ul style="list-style-type: none"> <li>• 'I add together the parts I know.' <math>345 + 198 = 543</math>.</li> <li>• 'Now I need to get from 534 to 999; that is another 6 and 50 and 400... so 456.'</li> </ul> <p>This strategy works well for some numbers, but for other problems (for example, those that require bridging) a different strategy may be more efficient. Ensure that children can confidently reframe the problem as a subtraction, for example:</p> $999 = 543 + \square$ <p>becomes</p> $543 = 999 - \square$ <p>so that they can clearly see that they can use other known subtraction strategies (including column subtraction).</p>	<ul style="list-style-type: none"> <li>• Performing the calculation</li> </ul> $\begin{array}{r} 2.55 \\ + 5.73 \\ \hline 8.28 \end{array}$ $2.55 + 5.73 = 8.28$ $\begin{array}{r} 15.10 \\ - 8.28 \\ \hline 6.82 \end{array}$ $15.1 - 8.28 = 6.82$ <p>so</p> $15.1 = \boxed{6.82} + 2.55 + 5.73$
<p><b>3:7</b> Provide children with varied missing-part problem practice, including word problems, measures contexts and missing-addend problems, for example:</p> <ul style="list-style-type: none"> <li>• 'I aim to walk 50 km over three days. I walk 15 km on the first day and <math>18\frac{1}{2}</math> km on the second day. How long do I have left to walk on the third day?'</li> <li>• 'There are 193 children in the school. 28 are in Reception. 55 are in Key Stage 1. How many are in Key Stage 2?'</li> </ul> <p>A wide range of contexts are presented in <i>Teaching point 4</i>, which you can use for both group work and independent practice. These include examples that children may not automatically connect to the part-part-whole structure.</p> <p>As discussed in the <i>Overview</i>, there is no need to encourage children to quickly move away from using the bar model, although once their</p>	<p>Missing-number problems: 'Fill in the missing numbers.'</p> $19.7 + 23.4 + \square = 65$ $3 \times 400 = 350 + 550 + \square$ <p>Dòng nào jìn: 'Find at least three different ways that this incorrect equation can be corrected by changing one of the values.'</p> $50 = 12.5 + 25 + 7.5 \times$

<p>understanding deepens, they may be able to confidently solve problems without drawing a model. Even in cases where children choose <i>not</i> to draw a model to help them solve a problem, it is worth occasionally asking them to represent what they have done with a bar model to highlight the structure and ensure the knowledge remains firmly embedded.</p>	
--	--

**Teaching point 4:**

Problems in many different contexts have the 'missing-part' structure.

Steps in learning

**Guidance**

**Representations**

**4:1** In the majority of these materials, each step in learning builds on, and moves forward from, the previous one. However in *this* teaching point, each step in learning shows the missing-part structure in a different context. A range of measures contexts have already been included above. The examples do not constitute an exhaustive list and the aim is not for children to rehearse every possible context; instead, ensure children are developing confidence in identifying the underlying structure for a given problem. The examples below reflect both Year 5 and Year 6 contexts; the intention is for this common-structure approach to remain a feature of children's problem-solving through the rest of Key Stage 2.

**4:2 Geometry**

Missing-part problems within geometry include:

- finding a missing angle in a triangle or other polygon
- finding a missing angle on a straight line
- finding a missing angle about a point
- finding a missing length in a polygon, given the perimeter.

Encourage children to interpret each problem and draw a bar model (as shown below) to link to the work they have been doing already on missing parts.

- 'Calculate the missing angles.'

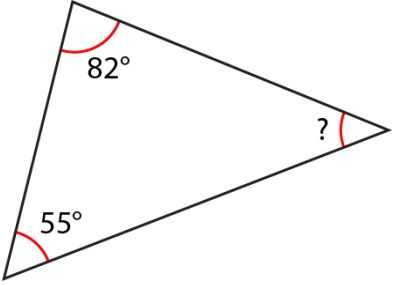
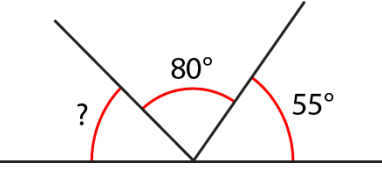
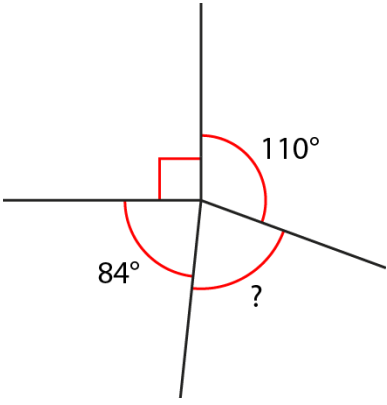
																						
<table border="1" style="margin: auto; border-collapse: collapse;"> <tr> <td colspan="3" style="padding: 5px;">180</td> </tr> <tr> <td style="padding: 5px;">55</td> <td style="padding: 5px;">82</td> <td style="padding: 5px;">?</td> </tr> </table>	180			55	82	?	<table border="1" style="margin: auto; border-collapse: collapse;"> <tr> <td colspan="3" style="padding: 5px;">180</td> </tr> <tr> <td style="padding: 5px;">?</td> <td style="padding: 5px;">80</td> <td style="padding: 5px;">55</td> </tr> </table>	180			?	80	55	<table border="1" style="margin: auto; border-collapse: collapse;"> <tr> <td colspan="4" style="padding: 5px;">360</td> </tr> <tr> <td style="padding: 5px;">84</td> <td style="padding: 5px;">90</td> <td style="padding: 5px;">110</td> <td style="padding: 5px;">?</td> </tr> </table>	360				84	90	110	?
180																						
55	82	?																				
180																						
?	80	55																				
360																						
84	90	110	?																			

- 'The rectangle has a perimeter of 13 m. Find the value of length  $b$ .'

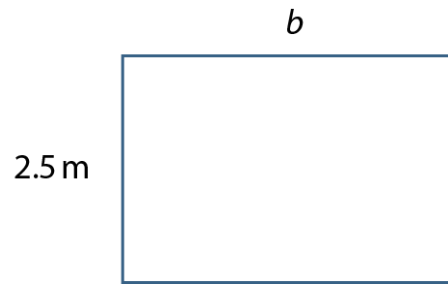

Dòng não jīn:

- 'An equilateral triangle and a right-angled triangle are positioned on a straight line.'

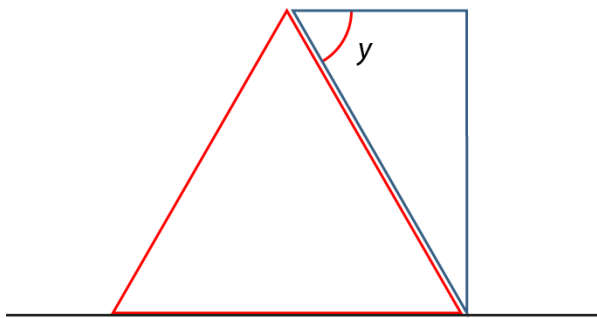

'What is the value of angle  $y$ ?'

- 'A square and four equilateral triangles are arranged as shown.'

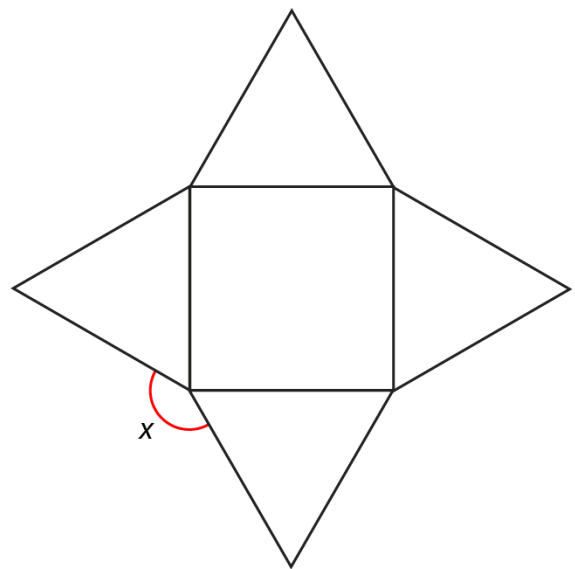

'What is the value of angle  $x$ ?'

- 'Charlie is redesigning his garden. The garden has a total area of  $661.5 \text{ m}^2$ . He builds a pond and a decking area as shown on the diagram.'

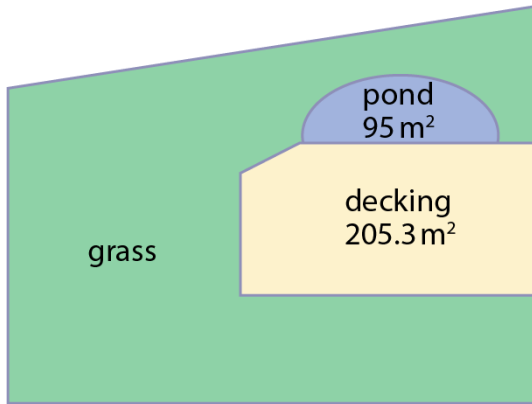

Not to scale

'Will Charlie have enough turf to grass the rest of the garden if he buys  $360 \text{ m}^2$ ? Explain your answer.'

- 'Charlie now needs to build a new fence along three sides of the garden. Each panel costs £9 and Charlie needs to buy £189-worth of panels. How many panels are needed for the longest length of fence?'

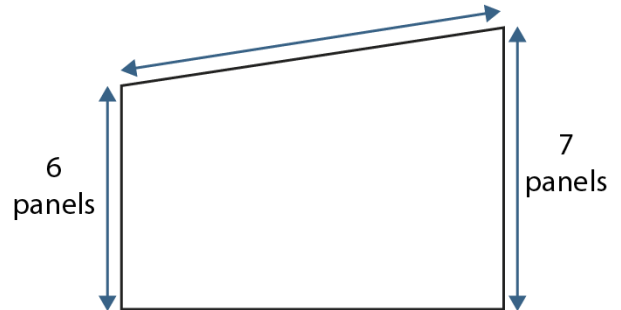

Not to scale

**4:3 Statistics: graphs**

Continue to encourage children to represent each problem using a bar model, before performing the calculation. They may not 'need' to do this to calculate the answer, but it highlights the repeating structure in all of these contexts.

Bar chart:

'The bar chart shows the results of a survey that asked 195 children how they travel to school. Complete the chart to show how many children travelled by bike.'

Children

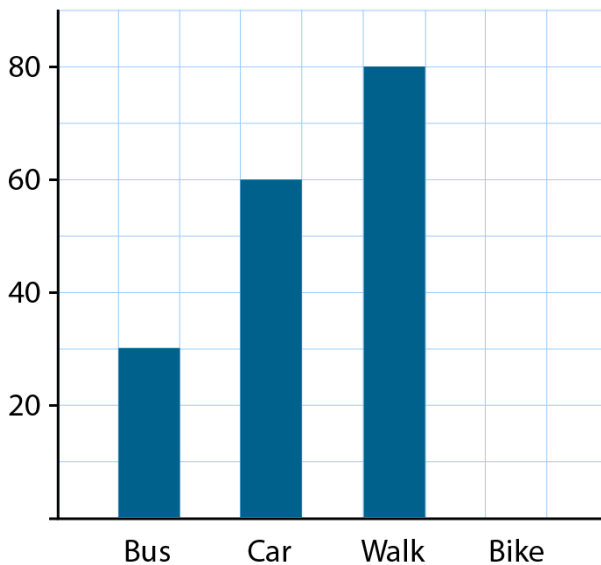

195			
30	60	80	?

Pie chart:

*'The pie chart shows the results of a school survey that asked about children's pets.'*

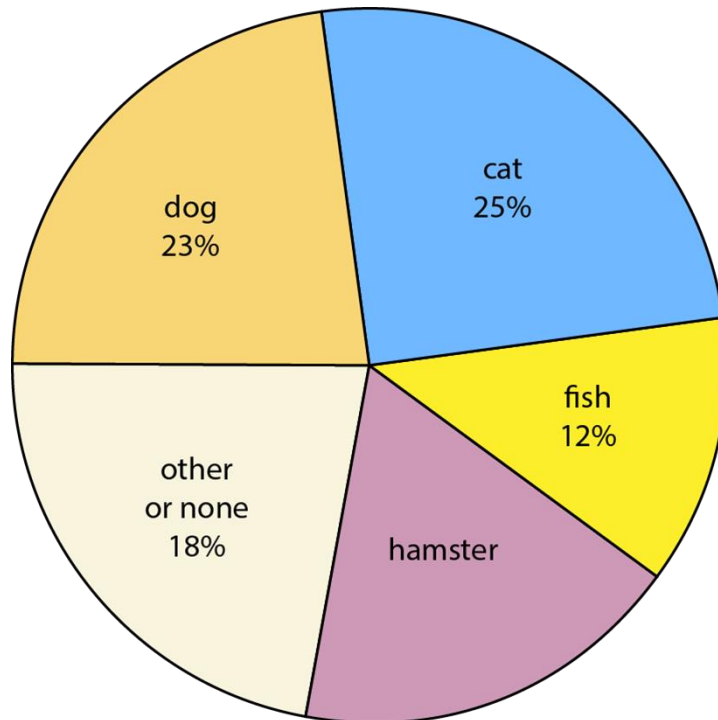

*'What percentage of children had a hamster?'*

#### 4:4 Statistics: tables

In the first example below, encourage children to tackle the problem by identifying rows/columns with just one missing part.

In the second example below, children will need to subtract 855,119 from one million. Using the column algorithm directly on this calculation is inefficient due to the need to exchange through multiple zeros. Instead, children could use the equivalent calculation  $999,999 - 855,118$ .

- 'Complete the table showing the favourite sports of 136 children.'*

Sport	Boys	Girls	Total
football	21	34	
hockey	27		
rounders		19	
<b>Total</b>	70		136

- 'A theme park hopes to attract one million visitors in a year. How many visitors does it need to attract in the last three months of the year to meet its target?'

Month	Number of visitors
January–March	138,890
April–June	289,419
July–September	426,810
October–December	

#### 4:5 Finding change:

Children should already have had plenty of practice calculating the change due when purchasing several items (segment 1.25 *Addition and subtraction: money*). Here, focus on using the bar model to represent the problem.

Children already have a range of mental strategies for adding and subtracting sums of money, such as using the adjusting approach, e.g.:

$$£12.99 + £5.49 + £6.99 = £13 + £5.50 + £7 - 3 \text{ p}$$

'Daisy is spending her birthday money. She buys a new t-shirt for £12.99, a baseball cap for £5.49 and some sunglasses for £6.99. How much change does she get from two £20 notes?'

£40			
£12.99	£5.49	£6.99	?

#### 4:6 Missing-number puzzles:

As with the table of sports data in step 4:4, encourage children to identify rows/columns/structures with just one missing part.

- 'Each row and column adds up to five. Fill in the missing numbers.'

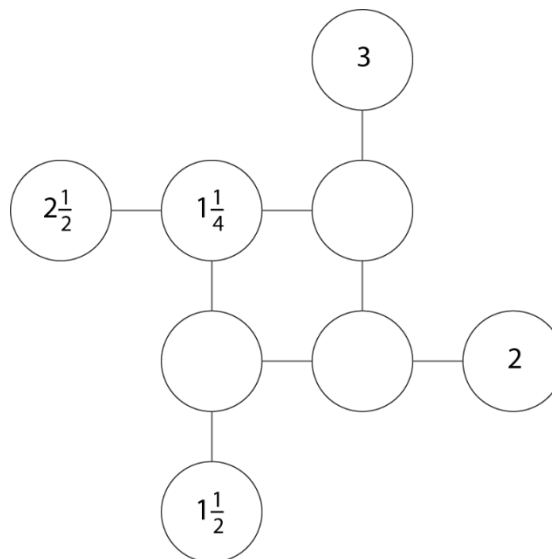



- 'The number in each circle is the sum of three numbers in the row below it. Fill in the missing numbers.'

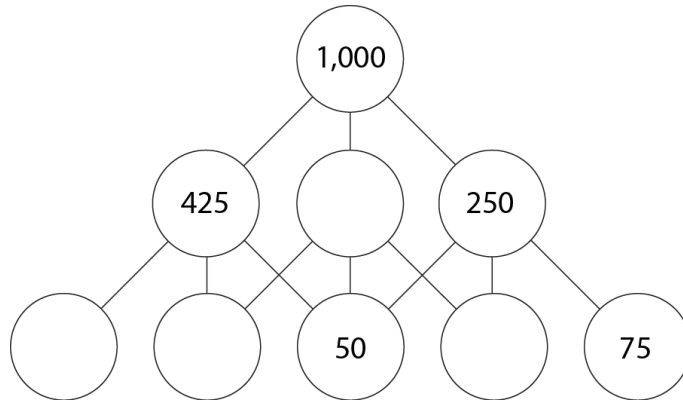

- 'The sum of each row, each column and each of the two long diagonals is 13.6. Fill in the missing numbers.'

		4.8	0.4
0.8			5.6
	4		
	2	3.6	1.6

### Appendix: Cuisenaire® rods

Cuisenaire® rods are proportional number sticks, ranging from 1 cm to 10 cm in length, in increments of 1 cm. Each length is represented by a different colour. No rod has any value in itself; rather, because there are no numeral markings, any sized rod can be chosen as the 'unit'. For example, if white represents one, then orange represents ten; if red is one, then orange is five.

To aid teachers and children with colour-vision deficiency, we have labelled each rod with its colour abbreviation, as shown below.

